

STI HORN STROBE SPEAKER DAMAGE STOPPER®

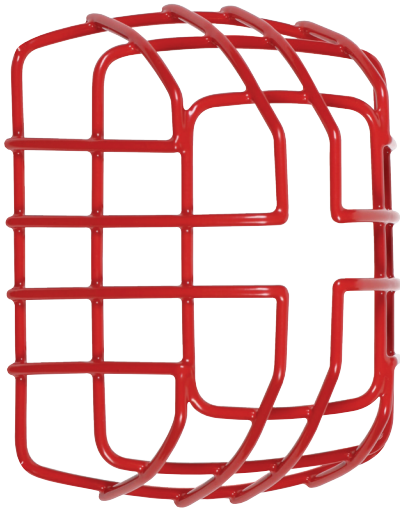

STI-9705-R

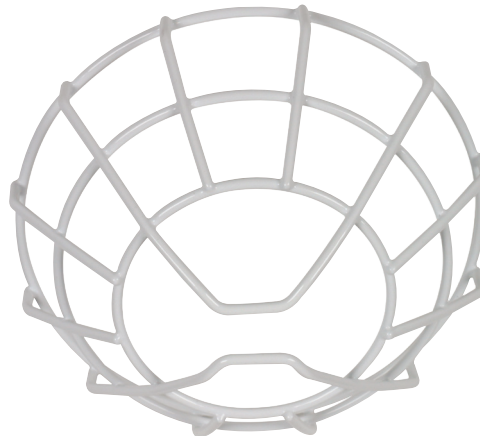

STI-9711



STI-9720

PRODUCT OVERVIEW

Here are excellent ways to protect strobe units against both vandalism and accidental damage. Constructed of tough, 9-gauge steel wire coated with corrosion resistant red or white polyester, these guards can take hard knocks in stride. STI-9705, STI-9708, STI-9711 and STI-9714 wire guards provide maximum protection for System Sensor SpectrAlert® Advance series strobe notification appliances.

BACKED BY A THREE YEAR GUARANTEE

As all STI protective covers, these guards are backed by a three year guarantee against breakage in normal use. Installation and servicing is easy with all screws and anchors provided. This Stopper is highly recommended for areas where abuse is severe or it is imperative that strobe units continue to operate. STI-9717 and STI-9720 fit over System Sensor notification appliances SP2R1224MC and SP2W1224MC.

KEY FEATURES

General Information

- Offers protection against vandalism and accidental damage.
- Simple removal for maintenance.
- For use in controlled environment (not intended for outdoor use).
- Three year guarantee against breakage in normal use.

Construction

- Constructed of tough 9-gauge steel wire.
- Coated with corrosion resistant polyester.

Installation

- Installation is fast and simple with screws and anchors provided.

Options

- STI-9705, STI-9708, STI-9711 and STI-9714 protect SpectrAlert® strobe units.
- STI-9717 and STI-9720 fit over System Sensor notification appliances P2R1224MC and SP2W1224MC.

STI Horn Strobe Speaker Damage Stopper®

Dimensions and Technical Information

MODELS AVAILABLE

- STI-9705** Damage Stopper, Flush Mount - White
- STI-9705-R** Damage Stopper, Flush Mount - Red
- STI-9708** Damage Stopper, Surface Mount - White
- STI-9708-R** Damage Stopper, Surface Mount - Red
- STI-9711** Damage Stopper, Flush Mount - White
- STI-9714** Damage Stopper, Surface Mount - White
- STI-9717** Speaker/Strobe Damage Stopper - Flush Mount (not UL Listed)
- STI-9720** Speaker/Strobe Damage Stopper - Surface Mount (not UL Listed)

MODEL	HEIGHT	WIDTH	DEPTH
STI-9705			
STI-9705-R	7.40 in. (188mm)	6.15 in. (156mm)	3.39 in. (86mm)
STI-9708			
STI-9708-R	7.49 in. (190mm)	6.74 in. (171mm)	6.09 in. (155mm)
STI-9711	8.26 in. (210mm)	8.26 in. (210mm)	3.54 in. (90mm)
STI-9714	8.55 in. (217mm)	8.55 in. (217mm)	6.23 in. (158mm)
STI-9717	6.1 in. (155mm)	9.3 in. (238mm)	2.4 in. (61mm)
STI-9720	6.1 in. (155mm)	9.3 in. (238mm)	4.9 in. (125mm)

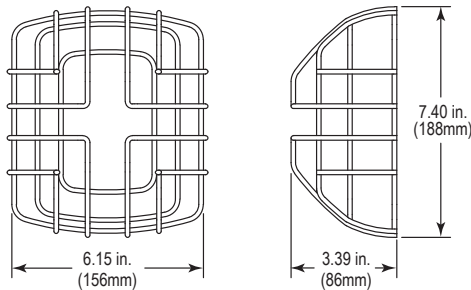

STI-9705

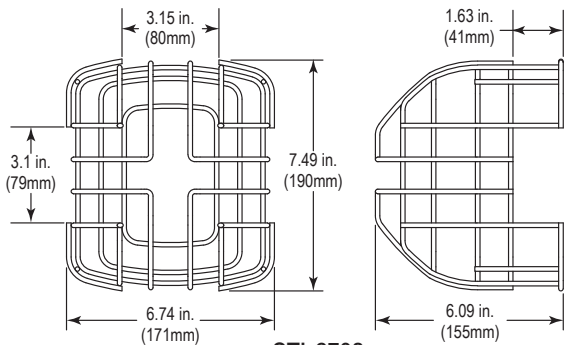

STI-9708

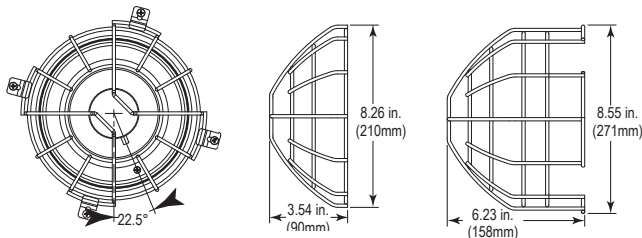

STI-9711

STI-9714

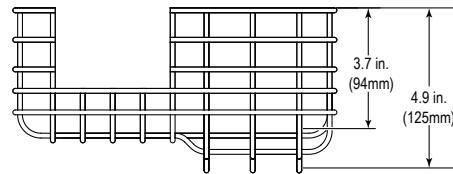

STI-9720
TOP VIEW

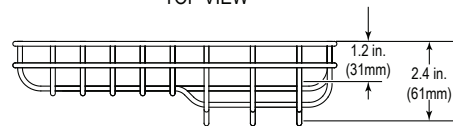

STI-9717
TOP VIEW

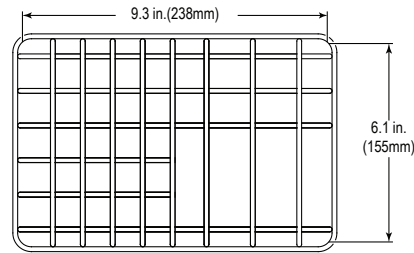

STI-9717 and STI-9720
FRONT VIEW

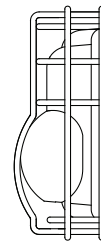

STI-9717
SIDE VIEW

APPROVALS & WARRANTY

TESTING

STI-9705, STI-9708, STI-9711 and STI-9714 have been tested and approved or listed by:

· Underwriter Laboratories and Canadian UL File S7025

WARRANTY

Three year guarantee against breakage in normal use.

Light De-Rating Factor

STI-9705 and STI-9708

System Sensor (SR, SW, SW-ALERT, SW-CLR-ALERT, SRK, SWK, P2R, P2W, P4R, P4W, CHSR, CHSW, P2RK, P2WK, P4RK, P4WK, SPSR, SPSR-SP, SPSR-PG, SPSW, SPSW-CLR-ALERT, SPSW-SP, SPSW-PG, SPSRV, SPSRV-SP, SPSRV-PG, SPSWV, SPSWV-SP and SPSWV-PG, SPSWK, SPSRK, SPSW-ALERT) **13%**

System Sensor (SRH, SWH, SRHK, SWH-ALERT, SWHK, P2RH, P2WH, P4RH, P2RHK, P2WHK, P2RHK-120, SPSRH, SPSRH-SP, SPSRH-PG, SPSWH, SPSWH-SP and SPSWH-PG, SPSRHK) **0%**

STI-9711 and STI-9714

System Sensor (SCR, SCW, SCRK, SCWK, SCW-CLR-ALERT, PC2R, PC2W, PC4R, PC4W, PC2RK, PC2WK, PC4WK, SPSCWV, SPSCR, SPSCR-SP, SPSCR-PG, SPSCW, SPSCW-SP, SPSCW-PG, SPSCRV, SPSCRV-PG, SPSCWV, SPSCWV-SP and SPSCWV-PG, SPSCWK, SPSCW-CLR-ALERT) **0%**

System Sensor (SCRH, SCWH, SCRHK, SCWHK, PC2RH, PC2WH, PC4RH, PC2RHK, PC4WHK, SPSCWHV, SPSCRH, SPSCRH-SP, SPSCRH-PG, SPSCWH, SPSCWH-SP, SPSCWH-PG, SPSCRVH, SPSCRVH-SP, SPSCRVH-PG, SPSCWHV-SP, SPSCWHV-PG, SPSCWHK) **0%**



Safety Technology International

2306 Airport Road info@sti-usa.com
Waterford, MI www.sti-usa.com
48327, USA Tel: 248-673-9898

Taylor House info@sti-emea.com
34 Sherwood Rd., Bromsgrove, www.sti-emea.com
Worcs., B60 3DR, England Tel: +44 (0) 1527 520 999

Unit 7A Lockheed Avenue
Airport Business Park
Waterford X91 HWF2 Ireland